

TLZ10

DIGITAL ELECTRONIC THERMOCONTROLLER



OPERATING INSTRUCTIONS

Vr. 02 (ENG) - 01/12 - cod.: ISTR-MTLZ10ENG02

ASCON TECHNOLOGIC S.r.l.

VIA INDIPENDENZA 56

27029 VIGEVANO (PV) ITALY

TEL.: +39 0381 69871

FAX: +39 0381 698730

<http://www.ascontecnologic.com>

e-mail: info@ascontecnologic.com

FOREWORD



This manual contains the information necessary for the product to be installed correctly and also instructions for its maintenance and use; we therefore recommend that the utmost attention is paid to the following instructions and to save it.

This document is the exclusive property of ASCON TECHNOLOGIC which forbids any reproduction and divulgation, even in part, of the document, unless expressly authorized.

ASCON ECNOLOGIC reserves the right to make any formal or functional changes at any moment and without any notice.

Whenever a failure or a malfunction of the device may cause dangerous situations for persons, thing or animals, please remember that the plant has to be equipped with additional devices which will guarantee safety.

ASCON TECHNOLOGIC and its legal representatives do not assume any responsibility for any damage to people, things or animals deriving from violation, wrong or improper use or in any case not in compliance with the instrument's features

INDEX

1	INSTRUMENT DESCRIPTION
1.1	GENERAL DESCRIPTION
1.2	FRONT PANEL DESCRIPTION
2	PROGRAMMING
2.1	PROGRAMMING OF SET POINT
2.2	PARAMETERS PROGRAMMING
2.3	PARAMETER PROTECTION USING THE PASSWORD
2.4	PARAMETERS PROGRAMMING LEVEL
2.5	ON / STAND-BY FUNCTION
3	INFORMATION ON INSTALLATION AND USE
3.1	PERMITTED USE
3.2	MECHANICAL MOUNTING
3.3	ELECTRICAL CONNECTIONS
3.4	ELECTRICAL WIRING DIAGRAM
4	FUNCTIONS
4.1	MEASURING AND VISUALIZATION
4.2	TEMPERATURE CONTROL
4.3	COMPRESSOR PROTECTION FUNCTION AND DELAY AT POWER-ON
4.4	FUNCTION OF KEY "U"
4.5	PARAMETERS CONFIGURATION BY A01
5	PROGRAMMABLE PARAMETERS TABLE
6	PROBLEMS , MAINTENANCE AND GUARANTEE
6.1	SIGNALLING
6.2	CLEANING
6.3	GUARANTEE AND REPAIRS
7	TECHNICAL DATA
7.1	ELECTRICAL DATA
7.2	MECHANICAL DATA
7.3	MECHANICAL DIMENSIONS, PANEL CUT-OUT AND MOUNTING
7.4	FUNCTIONAL DATA
7.5	INSTRUMENT ORDERING CODE

1 - INSTRUMENT DESCRIPTION

1.1 - GENERAL DESCRIPTION

TLZ 10 is a digital microprocessor based thermocontroller for Heating or Cooling applications and ON/OFF control mode. The instrument has one relay output and one input for PTC or NTC temperature probes that can be configured. The instrument is equipped with 4 programme keys, a 4-digit display and 1 LED signal. Other important characteristics of the instrument are: programme parameters protection using personalised password, switching on and off (stand-by) of the instrument using the "U" front key, configuration of parameters via the A01 device and the possibility of power supply in the range 100 ... 240 VAC.

1.2 - FRONT PANEL DESCRIPTION

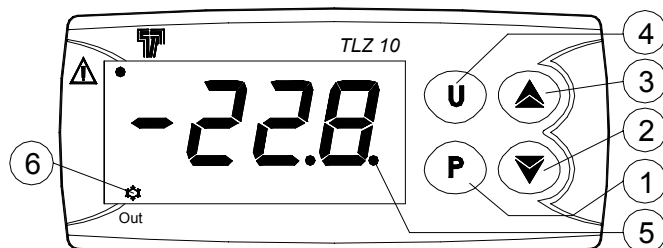

1 - Key P : Used for setting the Set point and for programming the function parameters

2 - Key DOWN : Used for decreasing the values to be set and for selecting the parameters.

3 - Key UP : Used for increasing the value to be set and for selecting the parameters.

4 - Key U : It can be programmed via the parameter "USrb" to turning on and off (stand-by) the device. In the "hidden" parameter programming mode it's used to modify the visibility of the parameters (see par. 2.4).

5 - Led SET : Indicates the input in programming mode and the programming level of the parameters. It also serves to indicate the Stand-by status.

6 - Led OUT : Indicates the control output status (or the temperature control device) on (on), off (off) or inhibited (flashing).

2 - PROGRAMMING

2.1 - PROGRAMMING OF THE SET POINT

Press the key **P** then release it and the display will show **SP** alternating with the set value.

To change it press the UP key to increase the value or DOWN to decrease it.

These keys increase or decrease the value one digit at a time, but if the button is pressed for more than one second the value increase or decreases rapidly, and after two seconds pressed, the speed increases even more to all the desired value to be reached rapidly.

Exiting the Set mode is achieved by pressing the P key or automatically if no key is pressed for 15 seconds. After that time the display returns to the normal function mode.

2.2 - PARAMETERS PROGRAMMING

To access the instrument's function parameters, press the key **P** and keep it pressed for about 5 seconds, after which the SET led will light up, the display will visualised the code that identifies the first parameter.

Using the UP and DOWN keys, the desired parameter can be selected and pressing the P key, the display will alternately show the parameter code and its setting that can be changed with the UP and DOWN keys.

Once the desired value has been set, press the key P again: the new value will be memorised and the display will show only the code of the selected parameter.

Pressing the UP and DOWN keys, it is possible to select another parameter and change it as described.

To exit the programming mode, do not press any key for about 20 seconds, or keep the UP or DOWN key pressed until it exits the programming mode.

2.3 - PARAMETER PROTECTION USING THE PASSWORD

The instrument has a parameter protection function using a password that can be personalised, through the "**PASS**" parameter.

If one wishes to have this protection, set the password number desired in the parameter "**PASS**".

When the protection is working, press the P key to access the parameters and keep it press for about 5 seconds, after which the LED SET will flash and the display will show "0".

At this point, using the UP and DOWN keys, set the password number programmed and press the key "P".

If the password is correct, the display will visualise the code that identifies the first parameter and it will be possible to programme the instrument in the same ways described in the previous section.

Protection using a password can be disabled by setting the parameter "**PASS**" = OFF.

2.4 - PARAMETERS PROGRAMMING LEVELS

The instrument has two parameter programming levels.

The first level ("visible" parameters) is accessed according to the procedure described above (with or without password request) while the second level ("hidden" password) can be accessed according to the following procedure.

Remove the power supply to the instrument, press the key P and return power to the instrument, keeping the key pressed.

After about 5 sec. the SET led will light up, the display will show the code that identifies the first parameter and it will be possible to set the parameters of the instrument using the same programming procedure described previously.

Once the parameter has been selected and the SET is on, it means that the parameter can be programmed even on the first level ("visible").

If the LED is off it means that the parameter can only be programmed on this level (i.e. "hidden").

To change the visibility of the parameter, press the key U: the led SET will change status, indicating the accessibility level of the parameter (on = parameter "visible"; off = parameter "hidden").

The access procedure for "hidden" parameters allows the "PASS" parameter to be checked and changed, and is useful therefore if the password set has been forgotten.

2.5 - ON / STAND-BY FUNCTION

The instrument, once powered up, can assume 2 different conditions:

- ON : means that the controller uses the control functions.

- STAND-BY : means that the controller does not use any control function and the display is turned off except for the green SET led.

If there is no power, and then power returns, the system always sets itself in the condition it was in before the black-out.

The ON/Stand-by function can be selected using the key U if the parameter "USrb" = 1 (see par. 4.4)

3 - INFORMATION ON INSTALLATION AND USE



3.1 - PERMITTED USE

The instrument has been projected and manufactured as a measuring and control device to be used according to EN61010-1 for the altitudes operation until 2000 ms. The use of the instrument for applications not expressly permitted by the above mentioned rule must adopt all the necessary protective measures. The instrument CANNOT be used in dangerous environments (flammable or explosive) without adequate protection. The installer must ensure that EMC rules are respected, also after the instrument installation, if necessary using proper filters. Whenever a failure or a malfunction of the device may cause dangerous situations for persons, thing or animals, please remember that the plant has to be equipped with additional devices which will guarantee safety.

3.2 - MECHANICAL MOUNTING

The instrument, in case 78 x 35 mm, is designed for flush-in panel mounting. Make a hole 71 x 29 mm and insert the instrument, fixing it with the provided special brackets. We recommend that the gasket is mounted in order to obtain the front protection degree as declared. Avoid placing the instrument in environments with very high humidity levels or dirt that may create condensation or introduction of conductive substances into the instrument. Ensure adequate ventilation to the instrument and avoid installation in containers that house devices which may overheat or which may cause the instrument to function at a higher temperature than the one permitted and declared. Connect the instrument as far away as possible from sources of electromagnetic disturbances such as motors, power relays, relays, solenoid valves, etc.

3.3 - ELECTRICAL CONNECTION

Carry out the electrical wiring by connecting only one wire to each terminal, according to the following diagram, checking that the power supply is the same as that indicated on the instrument and that the load current absorption is no higher than the maximum electricity current permitted.

As the instrument is built-in equipment with permanent connection inside housing, it is not equipped with either switches or internal devices to protect against overload of current: the installation will include an overload protection and a two-phase circuit-breaker, placed as near as possible to the instrument, and located in a position that can easily be reached by the user and marked as instrument disconnecting device which interrupts the power supply to the equipment.

It is also recommended that the supply of all the electrical circuits connected to the instrument must be protect properly, using devices (ex. fuses) proportionate to the circulating currents.

It is strongly recommended that cables with proper insulation, according to the working voltages and temperatures, be used.

Furthermore, the input cable of the probe has to be kept separate from line voltage wiring. If the input cable of the probe is screened, it has to be connected to the ground with only one side.

Whether the instrument is F (12 V) version it's recommended to use an external transformer TCTR, or with equivalent features (Class II insulation), and to use only one transformer for each instrument because there is no insulation between supply and input.

We recommend that a check should be made that the parameters are those desired and that the application functions correctly before connecting the outputs to the actuators so as to avoid malfunctioning that may cause irregularities in the plant that could cause damage to people, things or animals.

3.4 - ELECTRICAL WIRING DIAGRAM

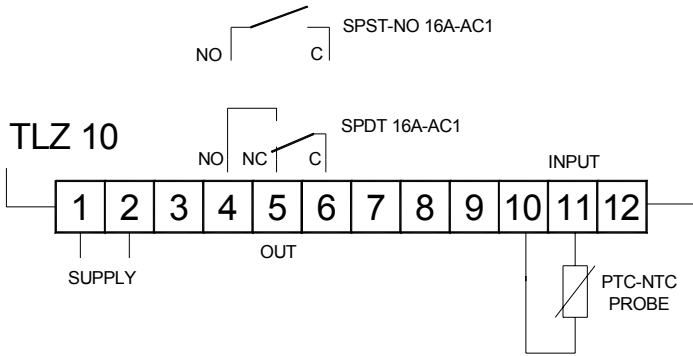

4 - FUNCTIONS

4.1 - MEASURING AND VISUALIZATION

Via the parameter "SEnS" it is possible to select the type of probes that one wishes to use and which can be: thermistores PTC KTY81-121 (Ptc) or NTC 103AT-2 (ntc).

Once the type of probe used has been selected, through the parameter "Unit", it is possible to select the temperature unit of measurement ($^{\circ}\text{C}$ or $^{\circ}\text{F}$) and, through the parameter "dP", the resolution of the desired measurement (OFF=1 $^{\circ}$; On=0,1 $^{\circ}$).

The instrument allows the measuring to be calibrated, that can be used for re-calibrating the instrument according to application needs, through the parameters "OFS".

Using the parameter "FIL", it is possible to set the time constant for the software filter for measuring the input values to be able to reduce the sensitivity to measurement disturbances (increasing the time).

4.2 - TEMPERATURE CONTROL

The regulation of the instrument is ON/OFF and acts on the output "OUT" depending on the measuring of probe, of the Set Point "SP", the intervention differential "HSEt" and the function mode "Func".

Depending on the function mode programmed on the parameter "Func" the differential is automatically considered by the regulator with positive values for a Refrigeration control ("Func"=Cool) and with negative values for a heating control ("Func"=HEAT).

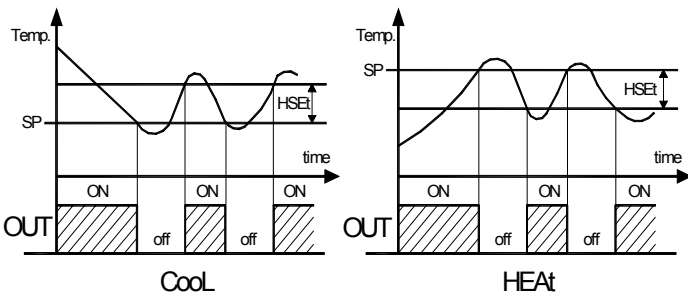

In the event of probe error, it is possible to set the instrument so that the output "OUT" continues to work in cycles according to the times programmed in the parameter "tonE" (activation time) and "toFE" (deactivation time).

If an error occurs on the probe the instrument activates the output for the time "tonE", then deactivates it for the time "toFE" and so on whilst the error remains.

Programming "tonE" = OFF the output in probe error condition will remain switched off.

Programming instead "tonE" to any value and "toFE" = OFF the output in probe error condition will remain switched on.

Remember that the temperature regulation function can be conditioned by the "Compressor Protection" function described below.

4.3 - COMPRESSOR PROTECTION FUNCTION AND DELAY AT POWER-ON

The function "Compressor Protection" carried out by the machine aims to avoid close start ups of the compressor controlled by the instrument in cooling applications.

This function foresees a time control on the switching on of the "OUT" output associated with the temperature regulation request.

The protection consists of preventing the output being switched on during the time set in the parameter "PtC" and counted depending on what has been programmed in the parameter "PSC", and therefore that any activation occurs only after the "PtC" time has finished.

If during the power on delay phase, the regulator request should disappear, due to an inhibition caused by the compressor protection function, the foreseen start up of the output is naturally cancelled.

Using the parameter "PSC", it is possible to set the type of compressor protection and therefore from when the inhibition time "PtC" must start.

The parameter "PSC" can be set as:

= 1 : Power on delay

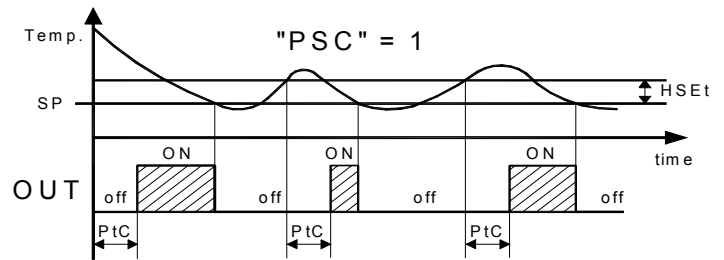

= 2 : Delay after power off

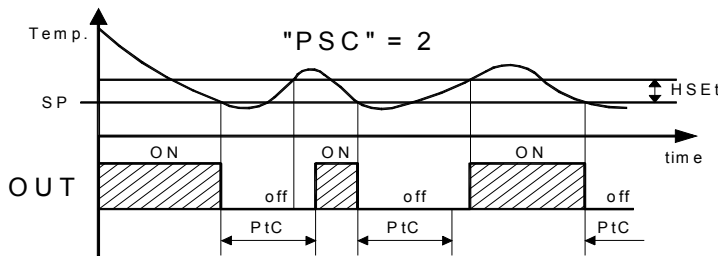

= 3 : Delay between power on phases.

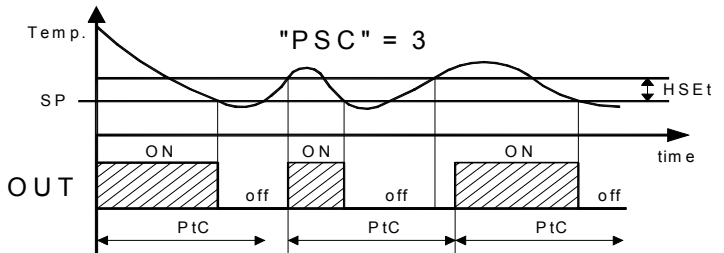

The function is disabled by programming "PtC" = 0.

During the power on delay phases of the OUT output by inhibiting the function "Compressor Protection" the led OUT flashes.

It is also possible to prevent activation of the output after the instrument is turned on, for the time set in the parameter "od".

The function is disabled by "od" = OFF.

During the power on delay phase, the display shows the indication od, alternating with the normal programmed visualisation.

4.4 - FUNCTIONING OF KEY "U"

The U key function can be defined by the parameter "USrb" and can be configured for the following functions:

= OFF - The key U carries out no function.

= 1 - Pressing the key for at least 1 second, it is possible to switch the instrument from the ON status to Stand-by status and vice versa.

4.5 - PARAMETERS CONFIGURATION BY "A01"

It is possible the transfer from and toward the instrument of the functioning parameters through the device A01 with 5 poles connector.

This device A01 it's mainly useable for the serial programming of the instruments which need to have the same parameters configuration or to keep a copy of the programming of an instrument and allow its rapid retransmission.

The same device can connect the instrument via USB to a PC and through the proper configuration software tools "TECNOLOGIC UniversalConf", it's possible to configure the operating parameters.

To use the device A01 it's necessary that the device or instrument are being supplied.

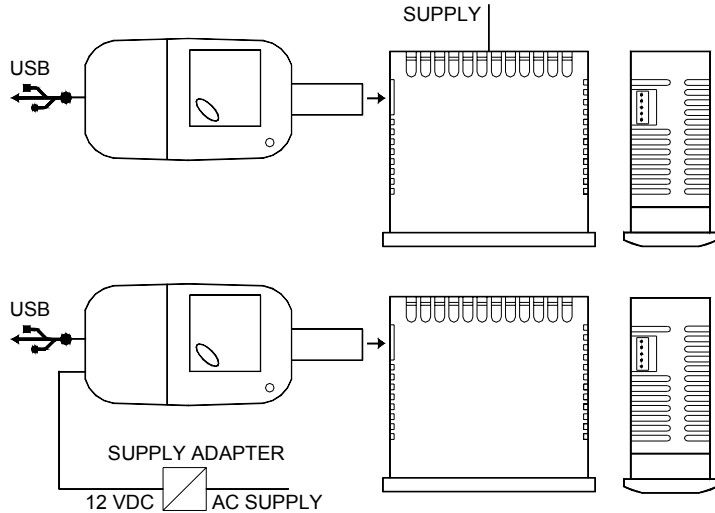

For additional info, please have a look at the A01 instruction manual.

5 - PROGRAMMABLE PARAMETERS TABLE

Here below is a description of all the parameters available on the instrument. Some of them may not be present because depend on the model/type of instrument.

Par.	Description	Range	Def.	Note
1	SPLL Minimum Set Point	-58.0 ÷ SPHL	-50.0	
2	SPHL Maximum Set Point	SPLL ÷ 302.0	100.0	
3	SEnS Probe Type	Ptc - ntc	Ptc	
4	OFS Probe Calibration	-30.0 ÷ 30.0 °C/°F	0.0	
5	Unit Unit of measurement	°C - °F	°C	
6	dP Decimal point	On - OFF	On	
7	FiL Measurement filter	OFF ÷ 20.0 sec	2.0	
8	HSEt Differential	0.0 ÷ 30.0 °C/°F	2.0	
9	tonE Activation time output OUT for probe broken	OFF ÷ 99.59 min.sec	OFF	
10	toFE Deactivation time output OUT for probe broken	OFF ÷ 99.59 min.sec	OFF	
11	Func Function mode output OUT	HEAt - Cool	Cool	
12	PSC Type of compressor protection: 1= delay at switch on 2= delay after switch off 3= delay between starts	1 - 2 - 3	1	
13	PtC Compressor protection time	OFF ÷ 99.59 min.sec	OFF	

14	od	Delay at power on	OFF ÷ 99.59 min.sec	OFF	
15	USrb	Function mode key U: OFF= No Function 1= ON/STAND-BY	OFF / 1	OFF	
16	PASS	Access Password to parameter functions	OFF ÷ 9999	OFF	
17	SP	Set Point	SPLL ÷ SPHL	0.0	

6 - PROBLEMS, MAINTENANCE AND GUARANTEE

6.1 - SIGNALLING

Error Signalling:

Error	Reason	Action
E1 -E1	The probe may be interrupted or in short circuit, or may measure a value outside the range allowed	Check the correct connection of the probe with the instrument and check the probe works correctly
EEPr	Internal memory error	Check and if necessary re-programme the parameters function.

In probe error status, the output OUT behaves as set by the parameters "tonE" and "toFE".

Other Signalling:

Message	Reason
od	Delay in switching on in progress

6.2 - CLEANING

We recommend cleaning of the instrument with a slightly wet cloth using water and not abrasive cleaners or solvents which may damage the instrument.

6.3 - GUARANTEE AND REPAIRS

The instrument is under warranty against manufacturing flaws or faulty material, that are found within 12 months from delivery date.

The guarantee is limited to repairs or to the replacement of the instrument.

The eventual opening of the housing, the violation of the instrument or the improper use and installation of the product will bring about the immediate withdrawal of the warranty's effects.

In the event of a faulty instrument, either within the period of warranty, or further to its expiry, please contact our sales department to obtain authorisation for sending the instrument to our company.

The faulty product must be shipped to ASCON TECNOLOGIC with a detailed description of the faults found, without any fees or charge for ASCON TECNOLOGIC, except in the event of alternative agreements.

7 - TECHNICAL DATA

7.1 - ELECTRICAL DATA

Power supply: 12 VAC/VDC, 24 VAC/VDC, 100..240 VAC +/- 10%

Frequency AC: 50/60 Hz

Power consumption: 3 VA approx.

Input/s: 1 input for temperature probes: PTC (KTY 81-121, 990 Ω @ 25 °C) or NTC (103AT-2, 10KΩ @ 25 °C)

Output/s: 1 relay output: OUT SPST-NO (16A-AC1, 6A-AC3 250 VAC) or SPDT 16A-AC1, 6A-AC3 250 VAC)

Electrical life for relay outputs: OUT SPST-NO: 100000 op. ; SPDT: 50000 op. (om. VDE)

Installation category: II

Measurement category: I

Protection class against electric shock: Class II for Front panel

Insulation: Reinforced insulation between the low voltage part (supply H type and relay outputs) and front panel; Reinforced insulation between the low voltage section (supply type H and relay outputs) and the extra low voltage section (inputs); Reinforced between supply and relay outputs; No insulation between supply F type and inputs.

7.2 - MECHANICAL DATA

Housing: Self-extinguishing plastic, UL 94 V0

Dimensions: 78 x 35 mm, depth 64 mm

Weight: 100 g approx.

Mounting: Flush in panel in 71 x 29 mm hole

Connections: 2,5 mm² screw terminals block

Degree of front panel protection : IP 65 mounted in panel with gasket

Pollution situation: 2

Operating temperature: 0 ... 50 °C

Operating humidity: 30 ... 95 RH% without condensation

Storage temperature: -10 ... +60 °C

7.3 - MECHANICAL DIMENSIONS, PANEL CUT-OUT AND MOUNTING [mm]

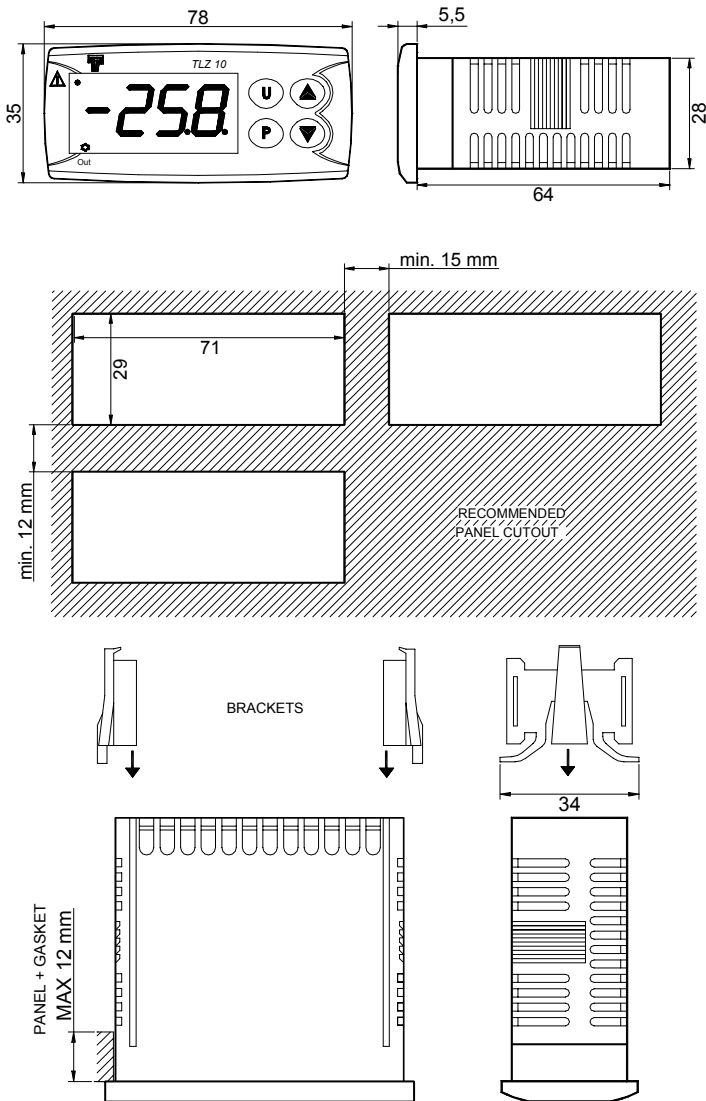

7.4 - FUNCTIONAL FEATURES

Temperature Control: ON/OFF mode

Measurement range: PTC: -50...150 °C / -58 ... 302 °F;

NTC: -50...109 °C / -58...228 °F

Display resolution: 1 ° or 0,1°

Overall accuracy: +/- 0,5 % fs

Sampling rate: 130 ms.

Display: 4 Digit Red h 12 mm

Compliance: ECC directive EMC 2004/108/CE (EN 61326), ECC

directive LV 2006/95/CE (EN 61010-1)

Approvals: C-UL (file n. E212227)

7.5 - INSTRUMENT ORDERING CODE

TLZ 10 a b cc d

a : POWER SUPPLY

H = 100...240 VAC

L = 24 VAC/VDC

F = 12 VAC/VDC

b : OUTPUT OUT TYPE

S = Relay SPDT 16A-AC1

R = Relay SPST-NO 16A-AC1

cc : SPECIAL CODES

d : SPECIAL VERSIONS